

Features

- Optimized for 1.8V systems
 - As fast as 3.5 ns pin-to-pin logic delays
 - As low as 14 μ A quiescent current
- Industries best 0.18 micron CMOS CPLD
 - Optimized architecture for effective logic synthesis
 - Multi-voltage I/O operation — 1.5V through 3.3V
- Available in multiple package options
 - 44-pin PLCC with 33 user I/O
 - 44-pin VQFP with 33 user I/O
 - 56-ball CP BGA with 33 user I/O
- Advanced system features
 - Fastest in system programming
 - 1.8V ISP using IEEE 1532 (JTAG) interface
 - IEEE1149.1 JTAG Boundary Scan Test
 - Optional Schmitt-trigger input (per pin)
 - FZP 100% CMOS product term generation
 - Flexible clocking modes
 - Optional DualEDGE triggered registers
 - Global signal options with macrocell control
 - Multiple global clocks with phase selection per macrocell
 - Multiple global output enables
 - Global set/reset
 - Efficient control term clocks, output enables and set/resets for each macrocell and shared across function blocks
 - Advanced design security
 - Open-drain output option for Wired-OR and LED drive
 - Optional configurable grounds on unused I/Os
 - Mixed I/O voltages compatible with 1.5V, 1.8V, 2.5V, and 3.3V logic levels
 - PLA architecture
 - Superior pinout retention
 - 100% product term routability across function block
 - Hot pluggable

Refer to the CoolRunner™-II family data sheet for architecture description.

Description

The CoolRunner-II 32-macrocell device is designed for both high performance and low power applications. This lends power savings to high-end communication equipment and high speed to battery operated devices. Due to the low power stand-by and dynamic operation, overall system reliability is improved.

This device consists of two Function Blocks inter-connected by a low power Advanced Interconnect Matrix (AIM). The AIM feeds 40 true and complement inputs to each Function Block. The Function Blocks consist of a 40 by 56 P-term PLA and 16 macrocells which contain numerous configuration bits that allow for combinational or registered modes of operation.

Additionally, these registers can be globally reset or preset and configured as a D or T flip-flop or as a D latch. There are also multiple clock signals, both global and local product term types, configured on a per macrocell basis. Output pin configurations include slew rate limit, bus hold, pull-up, open drain and programmable grounds. A Schmitt trigger input is available on a per input pin basis. In addition to storing macrocell output states, the macrocell registers may be configured as "direct input" registers to store signals directly from input pins.

Clocking is available on a global or Function Block basis. Three global clocks are available for all Function Blocks as a synchronous clock source. Macrocell registers can be individually configured to power up to the zero or one state. A global set/reset control line is also available to asynchronously set or reset selected registers during operation. Additional local clock, synchronous clock-enable, asynchronous set/reset and output enable signals can be formed using product terms on a per-macrocell or per-Function Block basis.

A DualEDGE flip-flop feature is also available on a per macrocell basis. This feature allows high performance synchronous operation based on lower frequency clocking to help reduce the total power consumption of the device.

The CoolRunner-II 32-macrocell CPLD is I/O compatible with standard LVTTTL and LVCMOS18, LVCMOS25, and LVCMOS33 (see [Table 1](#)). This device is also 1.5V I/O compatible with the use of Schmitt-trigger inputs.

Fast Zero Power Design Technology

Xilinx CoolRunner-II CPLDs are fabricated on a 0.18 micron process technology which is derived from leading edge FPGA product development. CoolRunner-II CPLDs employ Fast Zero Power™ (FZP), a design technique that makes use of CMOS technology in both the fabrication and design methodology. FZP design technology employs a cascade of CMOS gates to implement sum of products instead of traditional sense amplifier methodology. Due to this technology, Xilinx CoolRunner-II CPLDs achieve both high performance and low power operation.

Supported I/O Standards

The CoolRunner-II 32 macrocell features both LVCMOS and LVTTTL I/O implementations. See [Table 1](#) for I/O standard voltages. The LVTTTL I/O standard is a general purpose EIA/JEDEC standard for 3.3V applications that use an

LVTTTL input buffer and Push-Pull output buffer. The LVCMOS standard is used in 3.3V, 2.5V, 1.8V applications. CoolRunner-II CPLDs are also 1.5V I/O compatible with the use of Schmitt-trigger inputs.

Table 1: I/O Standards for XC2C32

I/O Types	Output V _{CCIO}	Input V _{CCIO}	Input V _{REF}	Board Termination Voltage V _T
LVTTTL	3.3	3.3	N/A	N/A
LVCMOS33	3.3	3.3	N/A	N/A
LVCMOS25	2.5	2.5	N/A	N/A
LVCMOS18	1.8	1.8	N/A	N/A
1.5V I/O	1.5	1.5	N/A	N/A

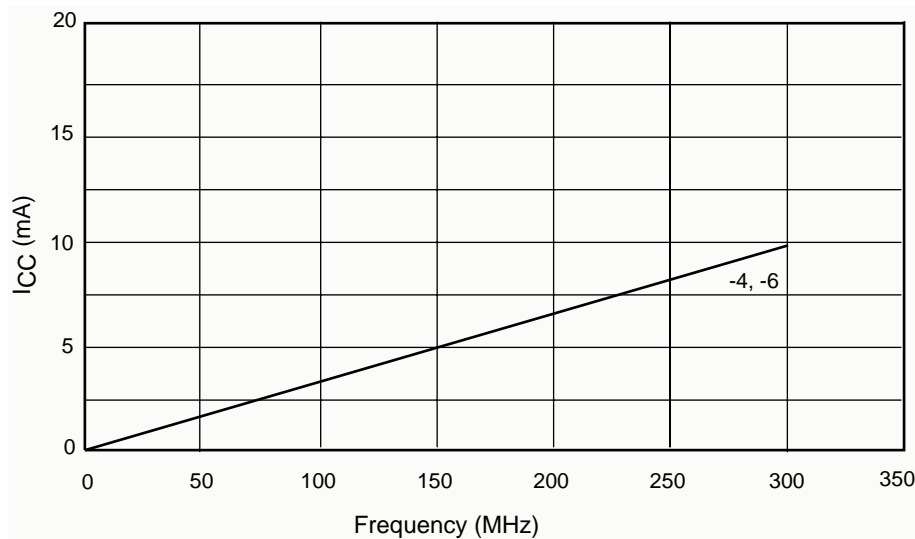

Figure 1: I_{CC} vs Frequency

Table 2: I_{CC} vs Frequency (LVCMOS 1.8V T_A = 25°C)⁽¹⁾

	Frequency (MHz)										
	0	25	50	75	100	150	175	200	225	250	300
Typical -4, -6 I _{CC} (mA)	0.018	0.87	1.75	2.61	3.44	5.16	5.99	6.81	7.63	8.36	9.93
Typical -3 I _{CC} (mA)											

Notes:

- 16-bit up/down, resettable binary counter (one counter per function block).

Absolute Maximum Ratings

Symbol	Description	Value	Units
V_{CC}	Supply voltage relative to ground	-0.5 to 2.0	V
V_{CCIO}	Supply voltage for output drivers	-0.5 to 4.0	V
V_{JTAG}	JTAG input voltage limits	-0.5 to 4.0	V
V_{AUX}	JTAG input supply voltage	-0.5 to 4.0	V
V_{IN}	Input voltage relative to ground ⁽¹⁾	-0.5 to 4.0	V
V_{TS}	Voltage applied to 3-state output ⁽¹⁾	-0.5 to 4.0	V
T_{STG}	Storage Temperature (ambient)	-65 to +150	°C
T_{SOL}	Maximum Soldering temperature (10s @ 1/16in. = 1.5mm)	+260	°C
T_J	Junction Temperature	+150	°C

Notes:

- Maximum DC undershoot below GND must be limited to either 0.5V or 10 mA, whichever is easiest to achieve. During transitions, the device pins may undershoot to -2.0v or overshoot to +4.5V, provided this over or undershoot lasts less than 10 ns and with the forcing current being limited to 200 mA.

Recommended Operating Conditions

Symbol	Parameter	Min	Max	Units	
V_{CC}	Supply voltage for internal logic and input buffers	Commercial $T_A = 0^{\circ}\text{C}$ to $+70^{\circ}\text{C}$	1.7	1.9	V
		Industrial $T_A = -40^{\circ}\text{C}$ to $+85^{\circ}\text{C}$	1.7	1.9	V
V_{CCIO}	Supply voltage for output drivers @ 3.3V operation	3.0	3.6	V	
	Supply voltage for output drivers @ 2.5V operation	2.3	2.7	V	
	Supply voltage for output drivers @ 1.8V operation	1.7	1.9	V	
	Supply voltage for output drivers @ 1.5V operation	1.4	1.6	V	
V_{AUX}	JTAG programming pins	1.7	3.6	V	

DC Electrical Characteristics (Over Recommended Operating Conditions)

Symbol	Parameter	Test Conditions	Max.	Units
I_{CCSB}	Standby current (-4, -6)	$V_{CC} = 1.9\text{V}$, $V_{CCIO} = 3.6\text{V}$	100	μA
I_{CCSB}	Standby current (-3)	$V_{CC} = 1.9\text{V}$, $V_{CCIO} = 3.6\text{V}$		mA
$I_{CC}^{(1)}$	Dynamic current (-4, -6)	$f = 1\text{ MHz}$	250	μA
		$f = 50\text{ MHz}$	2.5	mA
$I_{CC}^{(1)}$	Dynamic current (-3)	$f = 1\text{ MHz}$		mA
		$f = 50\text{ MHz}$		mA
C_{JTAG}	JTAG input capacitance	$f = 1\text{ MHz}$	10	pF
C_{CLK}	Global clock input capacitance	$f = 1\text{ MHz}$	12	pF
C_{IO}	I/O capacitance	$f = 1\text{ MHz}$	10	pF

Notes:

- 16-bit up/down resettable binary counter (one per Function Block) tested at $V_{CC} = V_{CCIO} = 1.9\text{V}$.

LVC MOS 3.3V and LV TTL 3.3V DC Voltage Specifications

Symbol	Parameter	Test Conditions	Min.	Max.	Units
V_{CCIO}	Input source voltage		3.0	3.6	V
V_{IH}	High level input voltage		2	3.9	V
V_{IL}	Low level input voltage		-0.3	0.8	V
V_{OH}	High level output voltage	$I_{OH} = -8 \text{ mA}, V_{CCIO} = 3\text{V}$	$V_{CCIO} - 0.4\text{V}$	-	V
		$I_{OH} = -0.1 \text{ mA}, V_{CCIO} = 3\text{V}$	$V_{CCIO} - 0.2\text{V}$	-	V
V_{OL}	Low level output voltage	$I_{OL} = 8 \text{ mA}, V_{CCIO} = 3\text{V}$	-	0.4	V
		$I_{OL} = 0.1 \text{ mA}, V_{CCIO} = 3\text{V}$	-	0.2	V
I_{IL}	Input leakage current	$V_{IN} = 0\text{V}$ or V_{CCIO} to 3.9V	-1	1	μA
I_{IH}	I/O High-Z leakage	$V_{IN} = 0\text{V}$ or V_{CCIO} to 3.9V	-1	1	μA

LVC MOS 2.5V DC Voltage Specifications

Symbol	Parameter	Test Conditions	Min.	Max.	Units
V_{CCIO}	Input source voltage		2.3	2.7	V
V_{IH}	High level input voltage		1.7	3.9	V
V_{IL}	Low level input voltage		-0.3	0.7	V
V_{OH}	High level output voltage	$I_{OH} = -8 \text{ mA}, V_{CCIO} = 2.3\text{V}$	$V_{CCIO} - 0.4\text{V}$	-	V
		$I_{OH} = -0.1 \text{ mA}, V_{CCIO} = 2.3\text{V}$	$V_{CCIO} - 0.2\text{V}$	-	V
V_{OL}	Low level output voltage	$I_{OL} = 8 \text{ mA}, V_{CCIO} = 2.3\text{V}$	-	0.4	V
		$I_{OL} = 0.1 \text{ mA}, V_{CCIO} = 2.3\text{V}$	-	0.2	V
I_{IL}	Input leakage current	$V_{IN} = 0\text{V}$ or V_{CCIO} to 3.9V	-1	1	μA
I_{IH}	I/O High-Z leakage	$V_{IN} = 0\text{V}$ or V_{CCIO} to 3.9V	-1	1	μA

LVC MOS 1.8V DC Voltage Specifications

Symbol	Parameter	Test Conditions	Min.	Max.	Units
V_{CCIO}	Input source voltage		1.7	1.9	V
V_{IH}	High level input voltage		$0.65 \times V_{CCIO}$	3.9	V
V_{IL}	Low level input voltage		-0.3	$0.35 \times V_{CCIO}$	V
V_{OH}	High level output voltage	$I_{OH} = -8 \text{ mA}, V_{CCIO} = 1.7\text{V}$	$V_{CCIO} - 0.45$	-	V
		$I_{OH} = -0.1 \text{ mA}, V_{CCIO} = 1.7\text{V}$	$V_{CCIO} - 0.2$	-	V
V_{OL}	Low level output voltage	$I_{OL} = 8 \text{ mA}, V_{CCIO} = 1.7\text{V}$	-	0.45	V
		$I_{OL} = 0.1 \text{ mA}, V_{CCIO} = 1.7\text{V}$	-	0.2	V
I_{IL}	Input leakage current	$V_{IN} = 0$ or V_{CCIO} to 3.9V	-1	1	μA
I_{IH}	I/O High-Z leakage	$V_{IN} = 0$ or V_{CCIO} to 3.9V	-1	1	μA

1.5V DC Voltage Specifications⁽¹⁾

Symbol	Parameter	Test Conditions	Min.	Max.	Units
V_{CCIO}	Input source voltage		1.4	1.6	V
V_{T+}	Input hysteresis threshold voltage		$0.5 \times V_{CCIO}$	$0.8 \times V_{CCIO}$	V
V_{T-}			$0.2 \times V_{CCIO}$	$0.5 \times V_{CCIO}$	V
V_{OH}	High level output voltage	$I_{OH} = -8 \text{ mA}, V_{CCIO} = 1.4\text{V}$	$V_{CCIO} - 0.45$	-	V
		$I_{OH} = -0.1 \text{ mA}, V_{CCIO} = 1.4\text{V}$	$V_{CCIO} - 0.2$	-	V
V_{OL}	Low level output voltage	$I_{OL} = 8 \text{ mA}, V_{CCIO} = 1.4\text{V}$	-	0.4	V
		$I_{OL} = 0.1 \text{ mA}, V_{CCIO} = 1.4\text{V}$	-	0.2	V
I_{IL}	Input leakage current	$V_{IN} = 0 \text{ or } V_{CCIO} \text{ to } 3.9\text{V}$	-1	1	μA
I_{IH}	I/O High-Z leakage	$V_{IN} = 0 \text{ or } V_{CCIO} \text{ to } 3.9\text{V}$	-1	1	μA

Notes:

1. Hysteresis used on 1.5V inputs.

Schmitt Trigger Input DC Voltage Specifications

Symbol	Parameter	Test Conditions	Min.	Max.	Units
V_{CCIO}	Input source voltage		1.4	3.9	V
V_{T+}	Input hysteresis threshold voltage		$0.5 \times V_{CCIO}$	$0.8 \times V_{CCIO}$	V
V_{T-}			$0.2 \times V_{CCIO}$	$0.5 \times V_{CCIO}$	V
I_{IL}	Input leakage current	$V_{IN} = 0 \text{ or } V_{CCIO} \text{ to } 3.9\text{V}$	-1	1	μA
I_{IH}	I/O High-Z leakage	$V_{IN} = 0 \text{ or } V_{CCIO} \text{ to } 3.9\text{V}$	-1	1	μA

AC Electrical Characteristics Over Recommended Operating Conditions

Symbol	Parameter	-3		-4		-6		Units
		Min.	Max.	Min.	Max.	Min.	Max.	
T _{PD1}	Propagation delay single p-term	-	3.2	-	3.8	-	5.5	ns
T _{PD2}	Propagation delay OR array	-	3.5	-	4.0	-	6.0	ns
T _{SUD}	Direct input register clock setup time	1.3	-	1.7	-	2.2	-	ns
T _{SU1}	Setup time fast (single p-term)	1.4	-	1.9	-	2.6	-	ns
T _{SU2}	Setup time (OR array)	1.7	-	2.1	-	3.1	-	ns
T _{HD}	Direct input register hold time	0	-	0	-	0	-	ns
T _H	P-term hold time	0	-	0	-	0	-	ns
T _{CO}	Clock to output	-	2.8	-	3.7	-	4.7	ns
F _{TOGGLE} ⁽¹⁾	Internal toggle rate	-	460	-	450	-	300	MHz
F _{SYSTEM1} ⁽²⁾	Maximum system frequency	-	333	-	323	-	200	MHz
F _{SYSTEM2} ⁽²⁾	Maximum system frequency	-	303	-	303	-	182	MHz
F _{EXT1} ⁽³⁾	Maximum external frequency	-	238	-	179	-	137	MHz
F _{EXT2} ⁽³⁾	Maximum external frequency	-	222	-	172	-	128	MHz
T _{PSUD}	Direct input register p-term clock setup time	0.3	-	0.4	-	0.9	-	ns
T _{PSU1}	P-term clock setup time (single p-term)	0.5	-	0.6	-	1.3	-	ns
T _{PSU2}	P-term clock setup time (OR array)	0.7	-	0.8	-	1.8	-	ns
T _{PHD}	Direct input register p-term clock hold time	1.4	-	1.5	-	1.6	-	ns
T _{PH}	P-term clock hold	1.2	-	1.3	-	0.7	-	ns
T _{PCO}	P-term clock to output	-	4.0	-	5.0	-	6.0	ns
T _{OE} /T _{OD}	Global OE to output enable/disable	-	3.5	-	4.2	-	5.5	ns
T _{POE} /T _{POD}	P-term OE to output enable/disable	-	4.8	-	5.5	-	6.7	ns
T _{MOE} /T _{MOD}	Macrocell driven OE to output enable/disable	-	4.5	-	5.0	-	6.9	ns
T _{PAO}	P-term set/reset to output valid	-	4.9	-	5.5	-	6.8	ns
T _{AO}	Global set/reset to output valid	-	4.0	-	4.5	-	5.5	ns
T _{SUEC}	Register clock enable setup time	1.5	-	2.0	-	3.0	-	ns
T _{HEC}	Register clock enable hold time	0	-	0	-	0	-	ns
T _{CW}	Global clock pulse width High or Low	1.2	-	1.4	-	2.2	-	ns
T _{PCW}	P-term pulse width High or Low	3.5	-	4.0	-	6.0	-	ns
T _{CONFIG} ⁽⁴⁾	Configuration time	-	50	-	50	-	50	μs

Notes:

1. F_{TOGGLE} is the maximum clock frequency to which a T-Flip Flop can reliably toggle (see the CoolRunner-II family data sheet for more information).
2. F_{SYSTEM1} (1/T_{CYCLE}) is the internal operating frequency for a device fully populated with one 16-bit counter through one p-term per macrocell while F_{SYSTEM2} is through the OR array.
3. F_{EXT1} (1/T_{SU1}+T_{CO}) is the maximum external frequency using one p-term while F_{EXT2} is through the OR array.
4. Typical configuration current during T_{CONFIG} is 500 μA.

Internal Timing Parameters

Symbol	Parameter ⁽¹⁾	-3		-4		-6		Units
		Min.	Max.	Min.	Max.	Min.	Max.	
Buffer Delays								
T _{IN}	Input buffer delay	-	1.0	-	1.4	-	1.7	ns
T _{DIN}	Direct register input delay	-	1.3	-	1.5	-	2.4	ns
T _{GCK}	Global Clock buffer delay	-	1.2	-	1.3	-	2.0	ns
T _{GSR}	Global set/reset buffer delay	-	1.5	-	1.6	-	2.0	ns
T _{GTS}	Global 3-state buffer delay	-	1.2	-	1.3	-	2.1	ns
T _{OUT}	Output buffer delay	-	1.4	-	1.8	-	2.0	ns
T _{EN}	Output buffer enable/disable delay	-	2.3	-	2.9	-	3.4	ns
P-term Delays								
T _{CT}	Control term delay	-	1.2	-	1.3	-	1.6	ns
T _{LOGI1}	Single p-term delay adder	-	0.3	-	0.4	-	1.1	ns
T _{LOGI2}	Multiple p-term delay adder	-	0.2	-	0.2	-	0.5	ns
Macrocell Delay								
T _{PDI}	Input to output valid	-	0.2	-	0.3	-	0.7	ns
T _{SUI}	Setup before clock	1.2	-	1.5	-	1.8	-	ns
T _{HI}	Hold after clock	0	-	0	-	0	-	ns
T _{ECSU}	Enable clock setup time	0.6	-	0.7	-	1.7	-	ns
T _{ECHO}	Enable clock hold time	0	-	0	-	0	-	ns
T _{COI}	Clock to output valid	-	0.5	-	0.6	-	0.7	ns
T _{AOI}	Set/reset to output valid	-	1.0	-	1.1	-	1.5	ns
T _{CDBL}	Clock doubler delay	-	0	-	0	-	0	ns
Feedback Delays								
T _F	Feedback delay	-	0.5	-	0.6	-	1.4	ns
T _{OEM}	Macrocell to global OE delay	-	0.2	-	0.2	-	0.8	ns
I/O Standard Time Adder Delays 1.5V I/O								
T _{HYS15}	Hysteresis input adder	-	2.0	-	3.0	-	4.0	ns
T _{OUT15}	Output adder	-	0.5	-	0.8	-	1.0	ns
T _{SLEW15}	Output slew rate adder	-	3.0	-	4.0	-	5.0	ns
I/O Standard Time Adder Delays 1.8V CMOS								
T _{IN18}	Standard input adder	-	0	-	0	-	0	ns
T _{HYS18}	Hysteresis input adder	-	2.0	-	3.0	-	4.0	ns
T _{OUT18}	Output adder	-	0	-	0	-	0	ns
T _{SLEW}	Output slew rate adder	-	3.0	-	4.0	-	5.0	ns

Internal Timing Parameters (Continued)

Symbol	Parameter ⁽¹⁾	-3		-4		-6		Units
		Min.	Max.	Min.	Max.	Min.	Max.	
I/O Standard Time Adder Delays 2.5V CMOS								
T _{IN25}	Standard input adder	-	0.5	-	0.8	-	1.0	ns
T _{HYS25}	Hysteresis input adder	-	2.0	-	3.0	-	4.0	ns
T _{OUT25}	Output adder	-	0.9	-	1.0	-	2.0	ns
T _{SLEW25}	Output slew rate adder	-	4.0	-	5.0	-	7.0	ns
I/O Standard Time Adder Delays 3.3V CMOS/TTL								
T _{IN33}	Standard input adder	-	0.7	-	0.8	-	1.0	ns
T _{HYS33}	Hysteresis input adder	-	2.0	-	3.0	-	4.0	ns
T _{OUT33}	Output adder	-	1.0	-	1.5	-	2.5	ns
T _{SLEW33}	Output slew rate adder	-	4.0	-	5.0	-	7.0	ns

Notes:

1. 1.5 ns input pin signal rise/fall.

Switching Characteristics

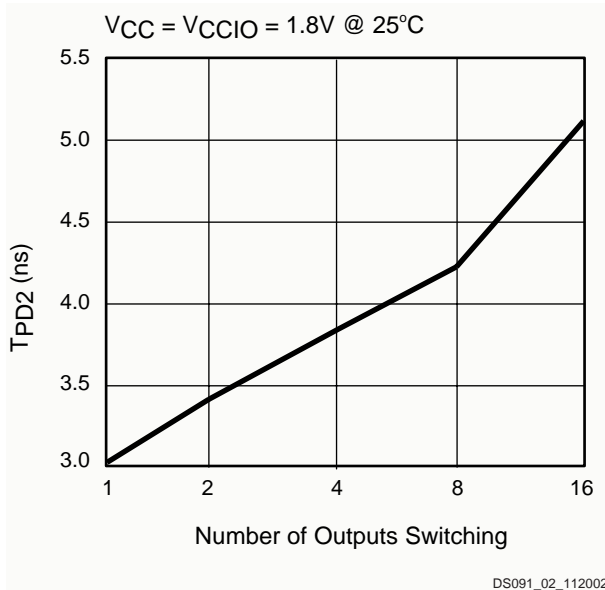
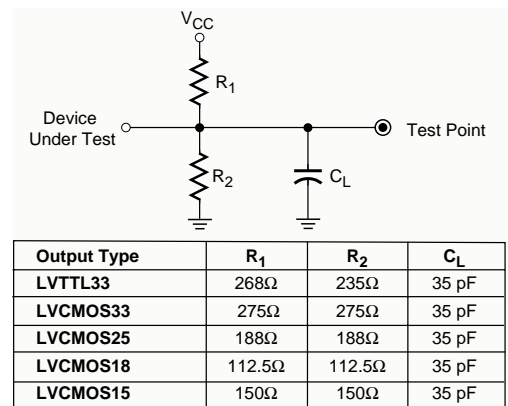

Figure 2: Derating Curve for T_{PD}



C_L includes test fixtures and probe capacitance.
1.5 ns maximum rise/fall times on inputs.

DS_ACT_08_14_02

Figure 3: AC Load Circuit

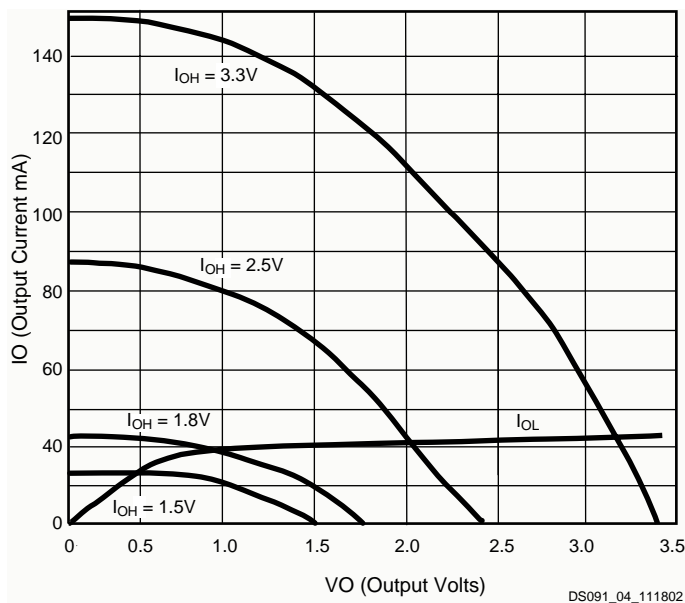

Figure 4: Typical I/V Curve for XC2C32

Pin Descriptions

Function Block	Macrocell	PC44	VQ44	CP56
1	1	44	38	F1
1	2	43	37	E3
1	3	42	36	E1
1(GTS1)	4	40	34	D1
1(GTS0)	5	39	33	C1
1(GTS3)	6	38	32	A3
1(GTS2)	7	37	31	A2
1(GSR)	8	36	30	B1
1	9	35	29	A1
1	10	34	28	C4
1	11	33	27	C5
1	12	29	23	C8
1	13	28	22	A10
1	14	27	21	B10
1	15	26	20	C10
1	16	25	19	E8
2	1	1	39	G1
2	2	2	40	F3
2	3	3	41	H1
2	4	4	42	G3
2(GCK0)	5	5	43	J1

Pin Descriptions (Continued)

Function Block	Macrocell	PC44	VQ44	CP56
2(GCK1)	6	6	44	K1
2(GCK2)	7	7	1	K2
2	8	8	2	K3
2	9	9	3	H3
2	10	11	5	K5
2	11	12	6	H5
2	12	14	8	H8
2	13	18	12	K8
2	14	19	13	H10
2	15	20	14	G10
2	16	22	16	F10

Notes:

1. GTS = global output enable, GSR = global set reset, GCK = global clock

XC2C32 Global, JTAG, Power/Ground and No Connect Pins

Pin Type	PC44	VQ44	CP56
TCK	17	11	K10
TDI	15	9	J10
TDO	30	24	A6
TMS	16	10	K9
Input Only	24	18	D10
V _{AUX} (JTAG supply voltage)	41	35	D3
Power internal (V _{CC})	21	15	G8
Power external I/O (V _{CCIO})	13, 32	7, 26	H6, C6
Ground	10, 23, 31	4, 17, 25	H4, F8, C7
No connects	-	-	K4, K6, K7, H7, E10, A7, A9, D8, A5, A8, A4, C3
Total user I/O	33	33	33

Ordering Information

Part Number	Pin/Ball Spacing	θ_{JA} (C/Watt)	θ_{JC} (C/Watt)	Package Type	Package Body Dimensions	I/O	Comm. (C) Ind. (I)
XC2C32-3PC44C	1.27mm	55.1	35.3	Plastic Leaded Chip Carrier	16.5mm x 16.5mm	33	C
XC2C32-4PC44C	1.27mm	55.1	35.3	Plastic Leaded Chip Carrier	16.5mm x 16.5mm	33	C
XC2C32-6PC44C	1.27mm	55.1	35.3	Plastic Leaded Chip Carrier	16.5mm x 16.5mm	33	C
XC2C32-3VQ44C	0.8mm	47.7	8.2	Very Thin Quad Flat Pack	10mm x 10mm	33	C

Part Number	Pin/Ball Spacing	θ_{JA} (C/Watt)	θ_{JC} (C/Watt)	Package Type	Package Body Dimensions	I/O	Comm. (C) Ind. (I)
XC2C32-4VQ44C	0.8mm	47.7	8.2	Very Thin Quad Flat Pack	10mm x 10mm	33	C
XC2C32-6VQ44C	0.8mm	47.7	8.2	Very Thin Quad Flat Pack	10mm x 10mm	33	C
XC2C32-3CP56C	0.5mm	66.0	14.9	Chip Scale Package	6mm x 6mm	33	C
XC2C32-4CP56C	0.5mm	66.0	14.9	Chip Scale Package	6mm x 6mm	33	C
XC2C32-6CP56C	0.5mm	66.0	14.9	Chip Scale Package	6mm x 6mm	33	C
XC2C32-6PC44I	1.27mm	55.1	35.3	Plastic Leaded Chip Carrier	16.5mm x 16.5mm	33	I
XC2C32-6VQ44I	0.8mm	47.7	8.2	Very Thin Quad Flat Pack	10mm x 10mm	33	I
XC2C32-6CP56I	0.5mm	66.0	14.9	Chip Scale Package	6mm x 6mm	33	I

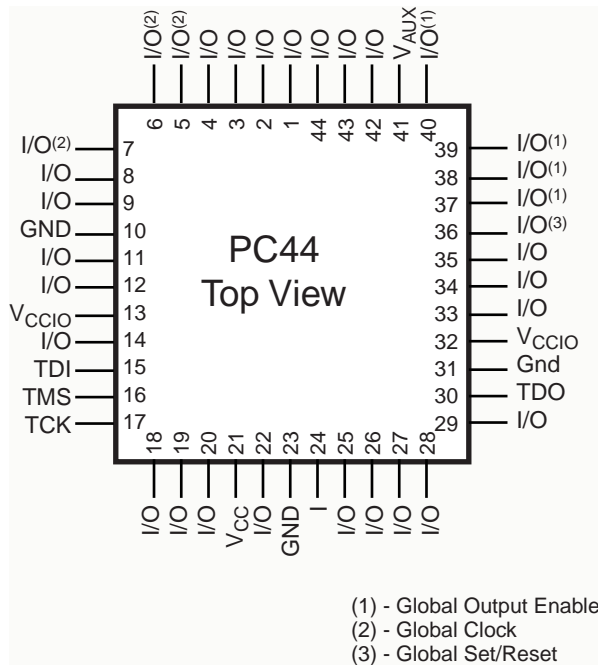

Figure 5: PC44 Package

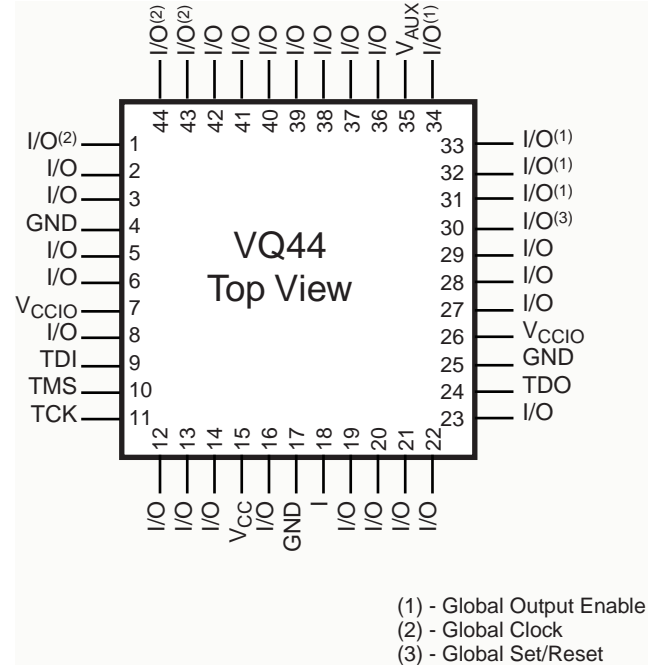

Figure 6: VQ44 Package

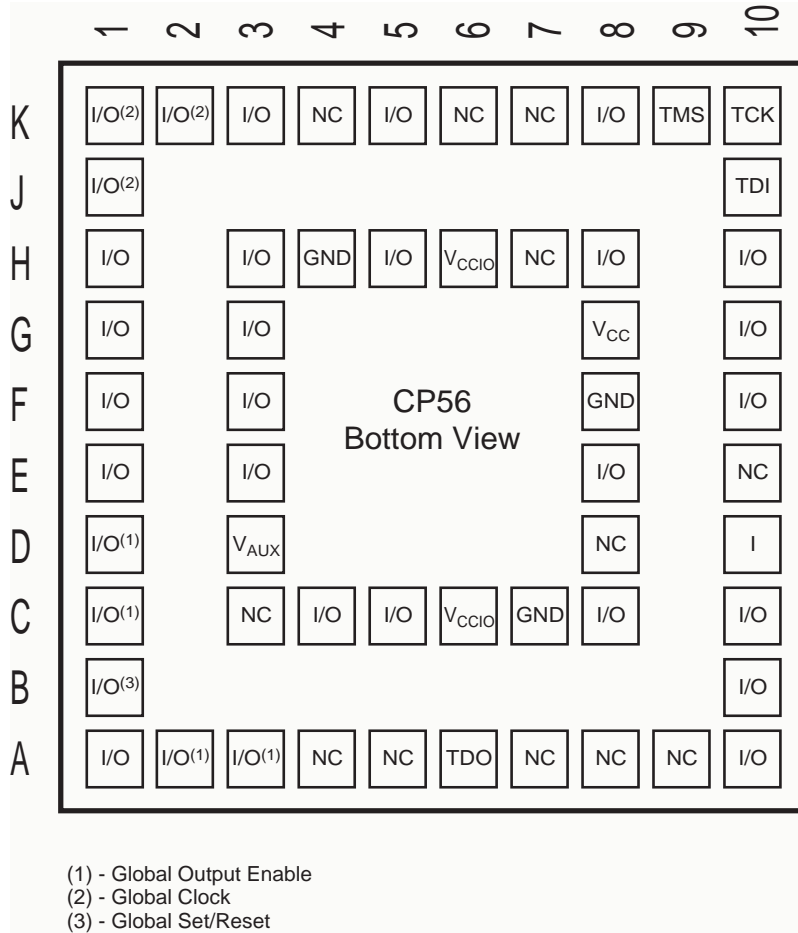

Figure 7: CP56 Package

Revision History

The following table shows the revision history for this document.

Date	Version	Revision
06/04/02	1.0	Initial Xilinx release.
10/18/02	1.1	Add AC characteristics and minor edits.
11/26/02	1.2	Minor edits.
01/09/03	1.3	Minor edits.
01/27/03	1.4	Updated Table 2, Typical -4, -6 device, at 0 from 0.025 to 0.018 mA